

MONO series

Cable carriers for
standard applications

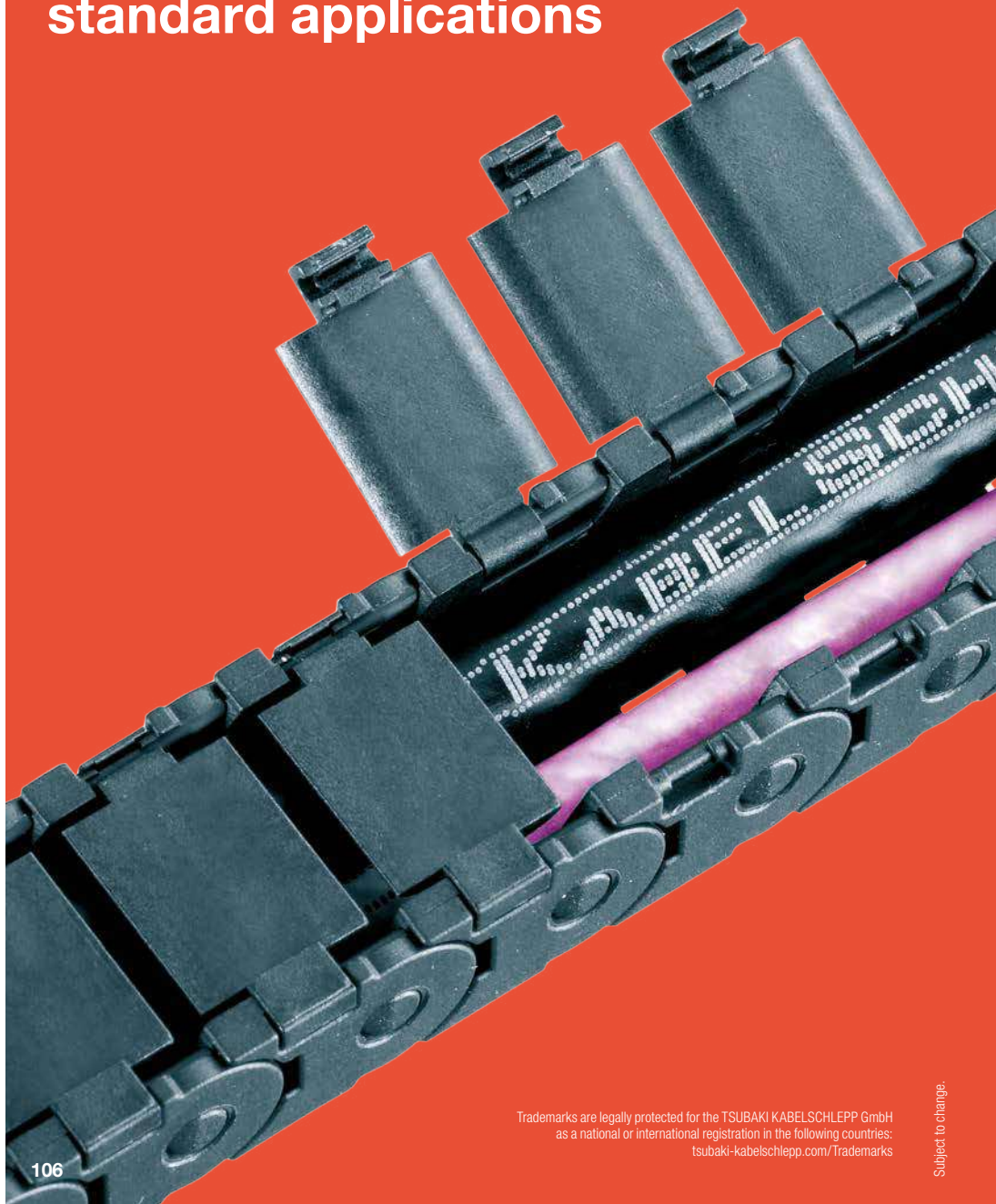

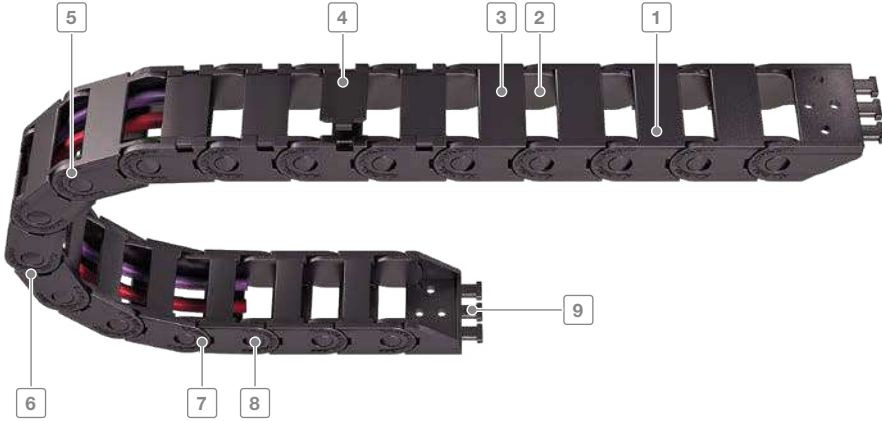

Inner heights



Inner widths



- 1 Plastic chain links
- 2 Inside space is gentle on the cables – no interfering edges
- 3 Types with single-part links
- 4 Types with opening crossbars
- 5 High torsional rigidity through large link surface
- 6 Extensive unsupported length and high additional loads through optimised stroke system
- 7 Easy to shorten and extend
- 8 Long service life through large bolt hole connection
- 9 End connectors with integrated strain relief

tsubaki-kabelschlepp.com/
mono

Features

- Cost-effective cable carrier
- Easy and fast installation
- Many types available immediately ex-stock world wide
- Long service life
- Great unsupported lengths compared to the unit size
- High torsional rigidity
- Easy to install



Small types for narrow installation spaces



Fast shortening/extending with push-to-connect chain links



Different connection variants through simple reconnecting of the end connectors

Key for abbreviations
on page 16

Type	Opening variant	Stay variant	h_i [mm]	h_G [mm]	B_i [mm]	B_k [mm]	B_i - grid [mm]	t [mm]	KR [mm]	Additional load ≤ [kg/m]	Cable- d_{max} [mm]
MONO 0130/..32/..34											



0132

10

12.5

6-40

12-46

-

13

20-37

0.5

8



0130

10

12.5

6-40

12-46

-

13

20-37

0.5

8



0134

10

12.5

6-20

12-26

-

13

20-37

0.5

8

MONO 0180/..82/..84



0182

15

18

10-40

18-48

-

18

28-50

1

12



0180

15

18

10-40

18-48

-

18

28-50

1

12



0184

15

18

15

23

-

18

28-50

1

12

MONO 0202



0202

11

15

6-20

13-27

-

20

18-50

1.2

8.5

Design guidelines
from page 62

Technical support:
technik@kabelschlepp.de



Technical manual

Do you need more information on the MONO series?
Our technical manual with all information on configuring your cable carrier can be found at tsubaki-kabelschlepp.com/download.

MONO series | Overview

MONO series

Unsupported arrangement			Gliding arrangement			Inner Distribution				Installation variants			Page
Travel length \leq [m]	$v_{max} \leq$ [m/s]	$a_{max} \leq$ [m/s ²]	Travel length \leq [m]	$v_{max} \leq$ [m/s]	$a_{max} \leq$ [m/s ²]	TS0	TS1	TS2	TS3	vertical hanging or standing	lying on the side	rotating arrangement	
1.15	10	50	40	3	30	-	-	-	-	•	•	-	112
1.15	10	50	40	3	30	-	-	-	-	•	•	-	113
1.15	10	50	-	-	-	-	-	-	-	•	•	-	114
1.55	10	50	70	3	30	-	-	-	-	•	•	-	118
1.55	10	50	70	3	30	-	-	-	-	•	•	-	119
1.55	10	50	-	-	-	-	-	-	-	•	•	-	120
1.95	10	50	70	3	30	-	-	-	-	•	•	•	124

Inner heights



Inner widths



tsubaki-kabelschlepp.com/mono

0130/..32/..34

Key for abbreviations on page 16

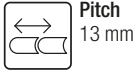

Pitch
13 mm



Inner height
10 mm

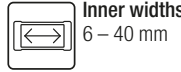

Inner widths
6 – 40 mm

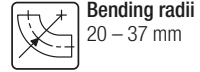

Bending radii
20 – 37 mm

Design guidelines from page 62

Technical support: technik@kabelschlepp.de

Types



Type 0132 page 112

Closed frame (design 020)

- Weight optimised, closed plastic frame with high torsional rigidity.
- **Outside/inside:** not openable.



Type 0130 page 113

Frame with outside opening crossbars (design 030)

- Weight optimised plastic frame with high torsional rigidity.
- Openable at any position.
- **Outside:** openable.



Type 0134 page 114

Frame with inside opening crossbars (design 040)

- Weight optimised plastic frame with high torsional rigidity.
- Openable at any position.
- **Inside:** openable.

Optimised cable carrier geometry:

Easy to shorten and extend

Long service life through large bolt hole connection



High torsional rigidity through large link surface

Extensive unsupported length and high additional loads through optimised stroke system

Unsupported arrangement

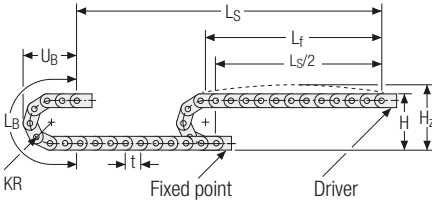

KR [mm]	H [mm]	H _z [mm]	L _B [mm]	U _B [mm]
20	52.5	62.5	89	40
28	68.5	78.5	114	48
37	86.5	96.5	142	57

Inner heights



Inner widths



Load diagram for unsupported length depending on the additional load.

Sagging of the cable carrier is technically permitted for extended travel lengths, depending on the specific application.

Intrinsic cable carrier weight $q_k = 0.16 \text{ kg/m}$ with $B_1 15 \text{ mm}$. For other inner widths, the maximum additional load changes.

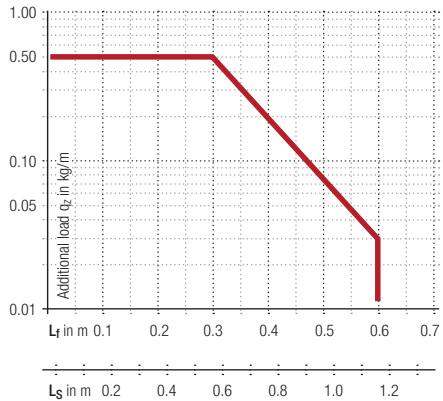

Speed
up to 10 m/s

Acceleration
up to 50 m/s²

Travel length
up to 1.15 m

Additional load
up to 0.5 kg/m

tsubaki-kabelschlepp.com/
mono

Gliding arrangement

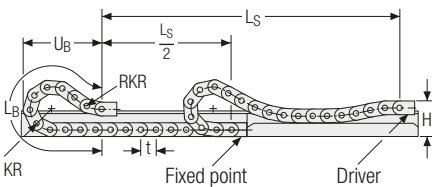

Speed
up to 3 m/s

Acceleration
up to 30 m/s²

The gliding cable carrier must be guided in a channel. See p. 732.

Only designs O20 and O30 can be used for a gliding arrangement.

Travel length
up to 40 m

Additional load
up to 0.5 kg/m

Type 0132 – closed frame

- Weight optimised, closed plastic frame with high torsional rigidity.
- **Outside/inside:** not openable.



Key for abbreviations on page 16

Design guidelines from page 62

Technical support: technik@kabelschlepp.de

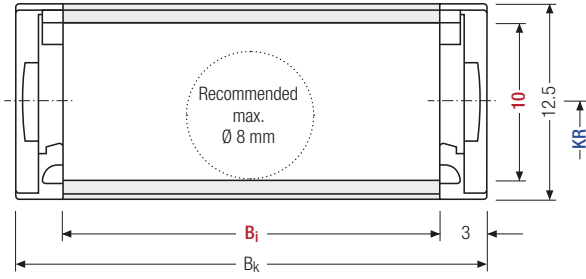
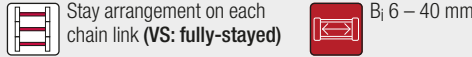

i The maximum cable diameter strongly depends on the bending radius and the desired cable type. Please contact us.

Calculating the cable carrier length

Cable carrier length L_k

$$L_k \approx \frac{L_s}{2} + L_B$$

Cable carrier length L_k rounded to pitch t

h_i [mm]	h_G [mm]	B_i [mm]				B_k [mm]	KR [mm]			q_k [kg/m]		
10	12.5	6	10	15	20	30*	40	$B_i + 6$	20	28	37	0.091 – 0.162

* On request

Order example

MONO Series · 0132 Type · 15 B_i [mm] · 28 KR [mm] · 390 L_k [mm] · VS Stay arrangement

Type 0130 – with outside opening crossbars

- Weight optimised plastic frame with high torsional rigidity.
- Openable at any position.
- **Outside:** openable.



Inner heights



Inner widths



Stay arrangement on each chain link (**VS: fully-stayed**)



B_i 6 – 40 mm

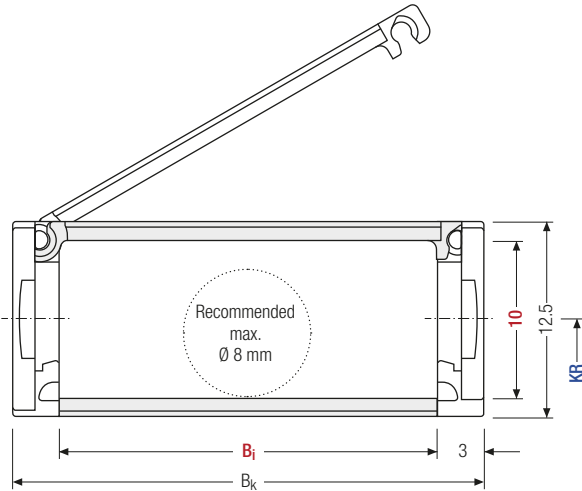

The maximum cable diameter strongly depends on the bending radius and the desired cable type. Please contact us.

Calculating the cable carrier length

Cable carrier length L_k

$$L_k \approx \frac{L_S}{2} + L_B$$

Cable carrier length L_k rounded to pitch t

h_i [mm]	h_G [mm]	B_i [mm]				B_k [mm]	KR [mm]			q_k [kg/m]	
10	12.5	6	10	15	20	40	$B_i + 6$	20	28	37	0.097 – 0.178

Order example



MONO	0130	15	28	390	VS
Series	Type	B_i [mm]	KR [mm]	L_k [mm]	Stay arrangement

Type 0134 – with inside opening crossbars

- Weight optimised plastic frame with high torsional rigidity.
- Openable at any position.
- **Outside:** openable.



Key for abbreviations on page 16



Stay arrangement on each chain link (**VS: fully-stayed**)



Bi 6 – 20 mm

Design guidelines from page 62

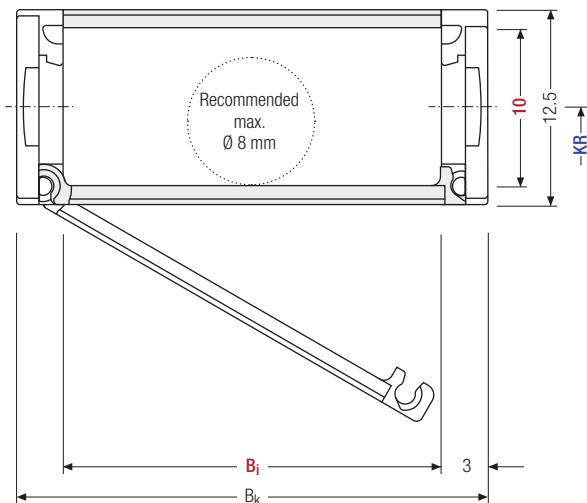

i The maximum cable diameter strongly depends on the bending radius and the desired cable type. Please contact us.

Calculating the cable carrier length

Cable carrier length L_k

$$L_k \approx \frac{L_s}{2} + L_B$$

Cable carrier length L_k rounded to pitch t

Technical support: technik@kabelschlepp.de

h_i [mm]	h_G [mm]	B_i [mm]			B_k [mm]	KR [mm]			q_k [kg/m]	
10	12.5	6	10	15	20	$B_i + 6$	20	28	37	0.099 – 0.132

Order example

MONO
Series
·
0134
Type
·
15
Bi [mm]
·
28
KR [mm]
·
390
L_k [mm]
-
VS
Stay arrangement

Single-part end connectors – plastic (with integrated strain relief)

The plastic end connectors can be connected **from above or below**. The connection type can be changed by altering the position of the end connector.

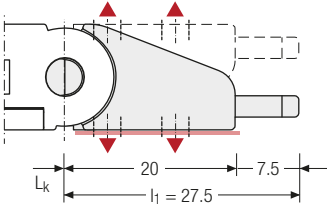

B_i: 6/10/15/20

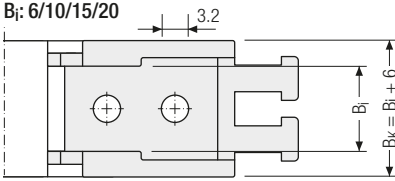

B_i: 30/40

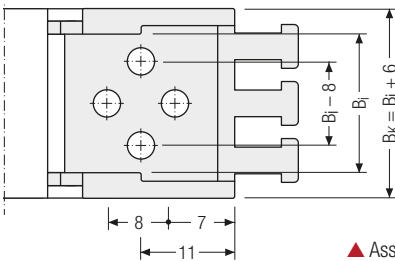

▲ Assembly options

Single-part end connectors – plastic

The plastic end connectors can be connected **from above or below**. The connection type can be changed by altering the position of the end connector.

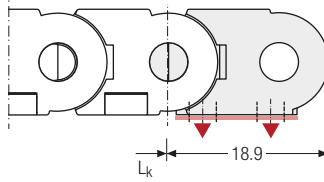

B_i: 6/10/15/20

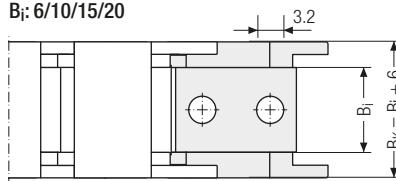

B_i: 30/40

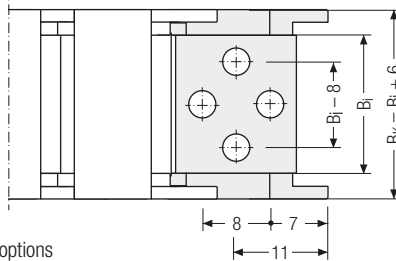

Connection point

F – fixed point
M – driver

Connection type

A – threaded joint outside (standard)
I – threaded joint inside

Connection point

F – fixed point
M – driver

Connection type

A – threaded joint outside (standard)
I – threaded joint inside

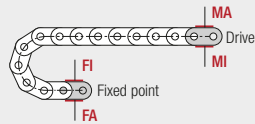
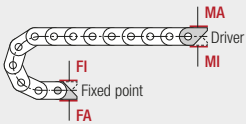

Order example



End connector	F	A
End connector	M	A
End connector	Connection point	Connection type



Depending on the design, the connection angles can be swivelled up to 12°.



0180/..82/..84

Key for abbreviations on page 16

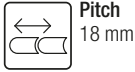

Pitch
18 mm



Inner height
15 mm

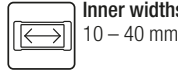

Inner widths
10 – 40 mm

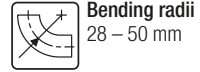

Bending radii
28 – 50 mm

Design guidelines from page 62

Technical support: technik@kabelschlepp.de

Types



Type 0182 page 118

Closed frame (design 020)

- Weight optimised, closed plastic frame with high torsional rigidity.
- **Outside/inside:** not openable.



Type 0180 page 119

Frame with outside opening crossbars (design 030)

- Weight optimised plastic frame with high torsional rigidity.
- Openable at any position.
- **Outside:** openable.



Type 0184 page 120

Frame with inside opening crossbars (design 040)

- Weight optimised plastic frame with high torsional rigidity.
- Openable at any position.
- **Inside:** openable.

Optimised cable carrier geometry:

Easy to shorten and extend

Long service life through large bolt hole connection



High torsional rigidity through large link surface

Extensive unsupported length and high additional loads through optimised stroke system

Unsupported arrangement

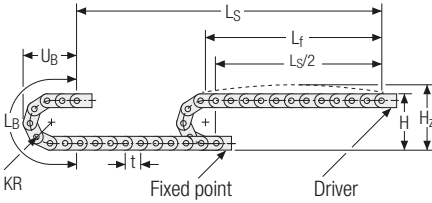

KR [mm]	H [mm]	H ₂ [mm]	L _B [mm]	U _B [mm]
28	74	89	124	55
37	92	107	153	64
50	118	133	194	77

Inner heights



Inner widths



Load diagram for unsupported length depending on the additional load.

Sagging of the cable carrier is technically permitted for extended travel lengths, depending on the specific application.

Intrinsic cable carrier weight $q_k = 0.25 \text{ kg/m}$ with $B_1 10 \text{ mm}$. For other inner widths, the maximum additional load changes.

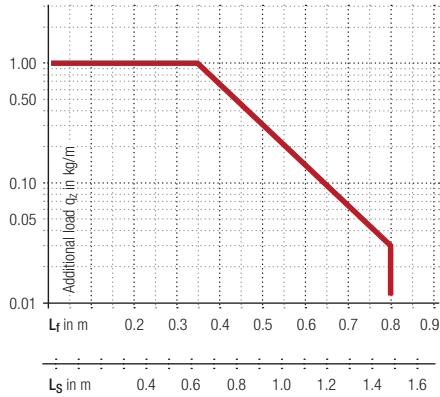

Speed
up to 10 m/s

Acceleration
up to 50 m/s²

Travel length
up to 1.5 m

Additional load
up to 1.0 kg/m

tsubaki-kabelschlepp.com/
mono

Gliding arrangement

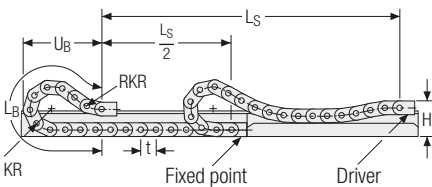

Speed
up to 3 m/s

Acceleration
up to 30 m/s²

The gliding cable carrier must be guided in a channel. See p. 732.

Only designs O20 and O30 can be used for a gliding arrangement.

Travel length
up to 70 m

Additional load
up to 1.0 kg/m

Type 0182 – closed frame

- Weight optimised, closed plastic frame with high torsional rigidity.
- **Outside/inside:** not openable.



Key for abbreviations on page 16



Stay arrangement on each chain link (**VS: fully-stayed**)



B_i 10 – 40 mm

Design guidelines from page 62

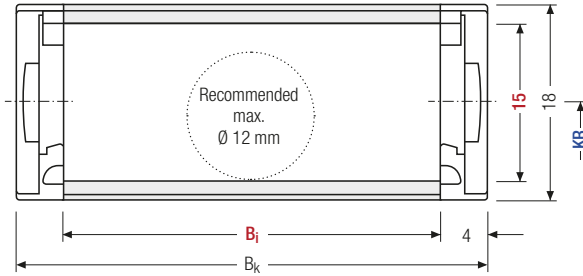

The maximum cable diameter strongly depends on the bending radius and the desired cable type. Please contact us.

Calculating the cable carrier length

Cable carrier length L_k

$$L_k \approx \frac{L_s}{2} + L_B$$

Cable carrier length L_k rounded to pitch t

Technical support: technik@kabelschlepp.de

h_i [mm]	h_G [mm]	B_i [mm]				B_k [mm]	KR [mm]			q_k [kg/m]	
15	18	10	15	20	30	40	$B_i + 8$	28	37	50	0.123 – 0.186

Order example

MONO Series · 0182 Type · 30 B_i [mm] · 37 KR [mm] · 720 L_k [mm] · VS Stay arrangement

Type 0180 – with outside opening crossbars

- Weight optimised plastic frame with high torsional rigidity.
- Openable at any position.
- **Outside:** openable.



Inner heights



Inner widths



Stay arrangement on each chain link (**VS: fully-stayed**)

B_i 10 – 40 mm

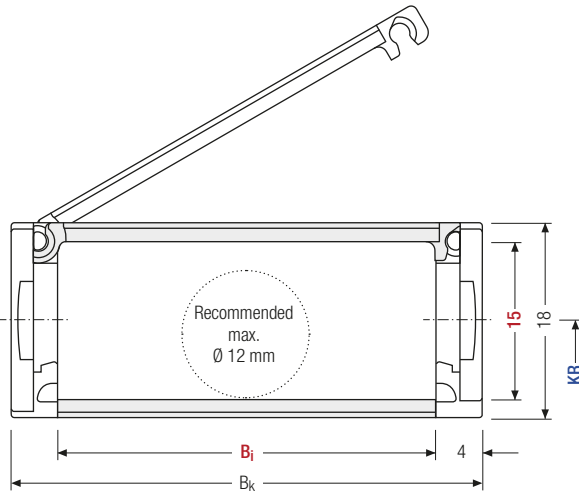

The maximum cable diameter strongly depends on the bending radius and the desired cable type. Please contact us.

Calculating the cable carrier length

Cable carrier length L_k

$$L_k \approx \frac{L_S}{2} + L_B$$

Cable carrier length L_k rounded to pitch t

tsubaki-kabelschlepp.com/
mono

h_i [mm]	h_G [mm]	B_i [mm]			B_k [mm]	KR [mm]			q_k [kg/m]		
15	18	10	15	20	30	40	$B_i + 8$	28	37	50	0.169 – 0.252

Order example

MONO Series · **0180** Type · **30** B_i [mm] · **37** KR [mm] · **720** L_k [mm] · **VS** Stay arrangement

Key for abbreviations
on page 16

Type 0184 – with inside opening crossbars

- Weight optimised plastic frame with high torsional rigidity.
- Openable at any position.
- **Inside:** openable.

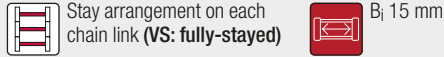

Design guidelines
from page 62

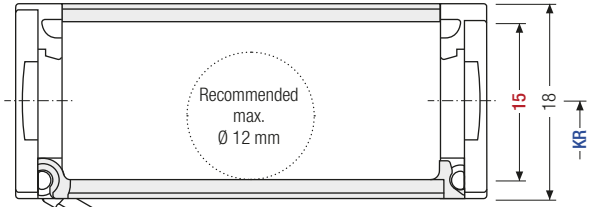

i The maximum cable diameter strongly depends on the bending radius and the desired cable type. Please contact us.

Calculating the cable carrier length

Cable carrier length L_k

$$L_k \approx \frac{L_s}{2} + L_B$$

Cable carrier length L_k rounded to pitch t

Technical support:
technik@kabelschlepp.de

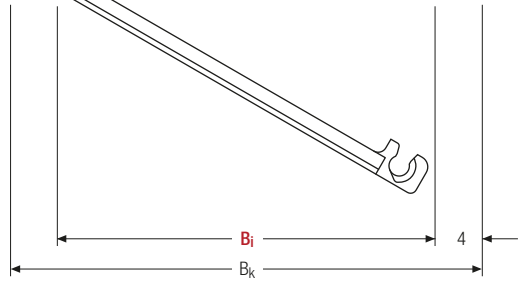

online-engineer.de
Cable Carrier Configurator

h_i [mm]	h_G [mm]	B_i [mm]			B_k [mm]	KR [mm]			q_k [kg/m]		
15	18	10	15	20	30	40	$B_i + 8$	28	37	50	0.133

Order example

MONO
Series
·
0184
Type
·
15
B_i [mm]
·
37
KR [mm]
·
720
L_k [mm]
-
VS
Stay arrangement

Single-part end connectors – plastic (with integrated strain relief)

The plastic end connectors can be connected **from above or below**. The connection type can be changed by altering the position of the end connector.

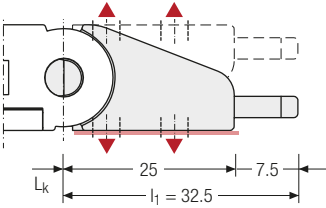

B_i: 10/15/20

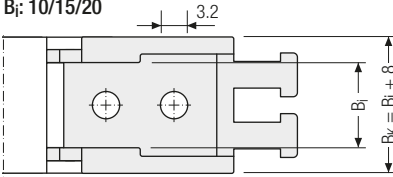

B_i: 30/40

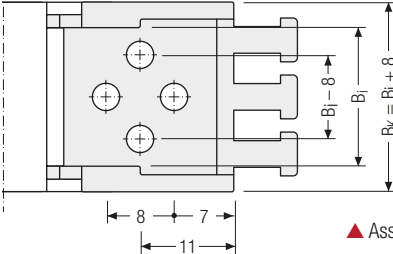

▲ Assembly options

Single-part end connectors – plastic

The plastic end connectors can be connected **from above or below**. The connection type can be changed by altering the position of the end connector.

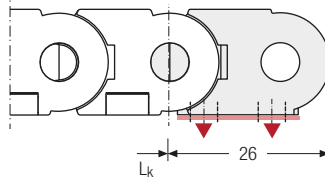

B_i: 10/15/20

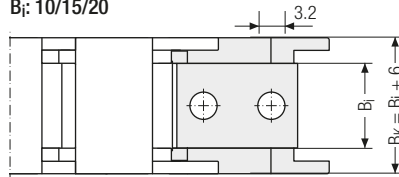

B_i: 30/40

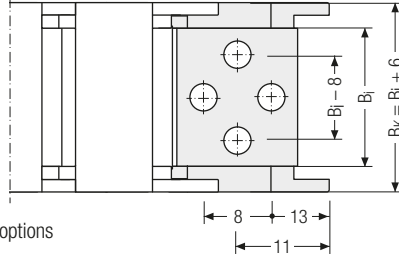

Inner heights



Inner widths



tsubaki-kabelschlepp.com/
mono

Connection point

- F – fixed point
- M – Driver

Connection type

- A – threaded joint outside (standard)
- I – threaded joint inside

Connection point

- F – fixed point
- M – Driver

Connection type

- A – threaded joint outside (standard)
- I – threaded joint inside

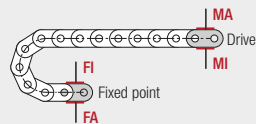
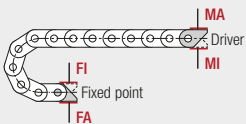

Order example



End connector	F	A
End connector	M	A
End connector	Connection point	Connection type

0202

Key for abbreviations on page 16



Pitch
20 mm



Inner height
11 mm



Inner widths
6 – 20 mm



Bending radii
18 – 50 mm

Types



Type 0202 page 124

Closed frame (design 020)

- Weight optimised, closed plastic frame with high torsional rigidity.
- **Outside/inside:** not openable.

Design guidelines from page 62

Technical support: technik@kabelschlepp.de

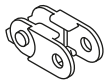

Fast cable laying – 0202 slotted version

The slotted variant of the MONO 0202 allows fast and easy pressing in of cables without opening the cable carrier. That saves time and therefore money. It is particularly suitable for cables with pre-assembled connectors. Please contact us!



Unsupported arrangement

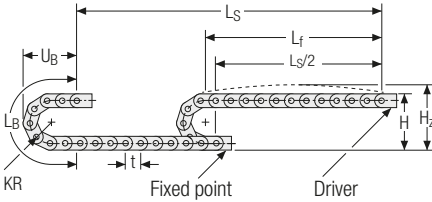

KR [mm]	H [mm]	H _z [mm]	L _B [mm]	U _B [mm]
18	51	61	97	45.5
28	71	81	128	55.5
38	91	101	160	65.5
50	115	125	198	77.5

Inner heights



Inner widths



Load diagram for unsupported length depending on the additional load.

Sagging of the cable carrier is technically permitted for extended travel lengths, depending on the specific application.

Intrinsic cable carrier weight $q_k = 0.18 \text{ kg/m}$ with $B_i 10 \text{ mm}$. For other inner widths, the maximum additional load changes.

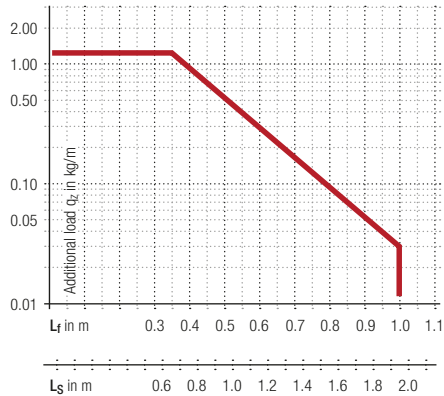

Speed
up to 10 m/s

Acceleration
up to 50 m/s²

Travel length
up to 1.95 m

Additional load
up to 1.25 kg/m

Gliding arrangement

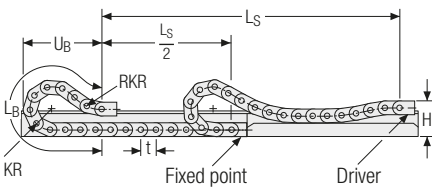

Speed
up to 3 m/s

Acceleration
up to 30 m/s²

The gliding cable carrier must be guided in a channel. See p. 732.

Travel length
up to 70 m

Additional load
up to 1.0 kg/m

Type 0202 – closed frame

- Weight optimised, closed plastic frame with high torsional rigidity.
- Outside/inside: not openable.



Key for abbreviations on page 16



Stay arrangement on each chain link (VS: fully-stayed)



B_i 6 – 20 mm

Design guidelines from page 62

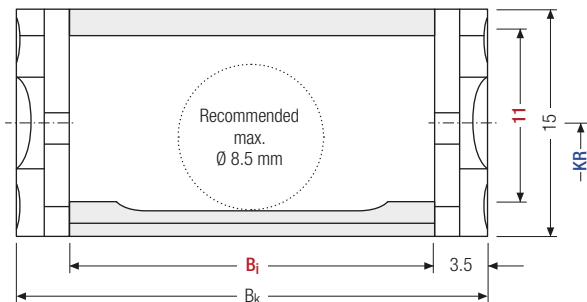

The maximum cable diameter strongly depends on the bending radius and the desired cable type. Please contact us.

Calculating the cable carrier length

Cable carrier length L_k

$$L_k \approx \frac{L_s}{2} + L_B$$

Cable carrier length L_k rounded to pitch t

Technical support: technik@kabelschlepp.de

h_i [mm]	h_G [mm]	B_i [mm]			B_k [mm]	KR [mm]				q_k [kg/m]	
11	15	6	10	15	20	$B_i + 7$	18	28	38	50	0.14 – 0.17

Order example

MONO
Series
·
0202
Type
·
10
 B_i [mm]
·
28
KR [mm]
·
460
 L_k [mm]
·
VS
Stay arrangement

Single-part end connectors – plastic (with integrated strain relief)

The plastic end connectors can be connected **from above or below**. The connection type can be changed by altering the position of the end connector.

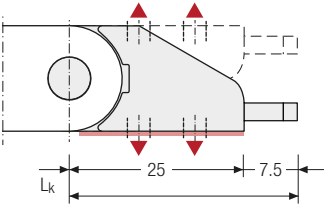

▲ Assembly options

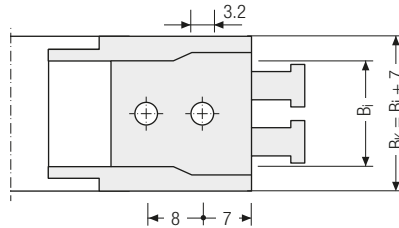

Inner heights



Inner widths



tsubaki-kabelschlepp.com/
mono

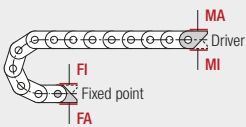

Connection point

F – fixed point
M – driver

Connection type

A – threaded joint outside (standard)
I – threaded joint inside

Order example



End connector	.	F	A
End connector	.	M	A
End connector		Connection point	Connection type

Additional product information online



Installation instructions, etc.:
Additional info via your smartphone or check online at tsubaki-kabelschlepp.com/support



Configure your cable carrier here:
onlineengineer.de