

LS/LSX series

Cost-effective steel chains
with light design

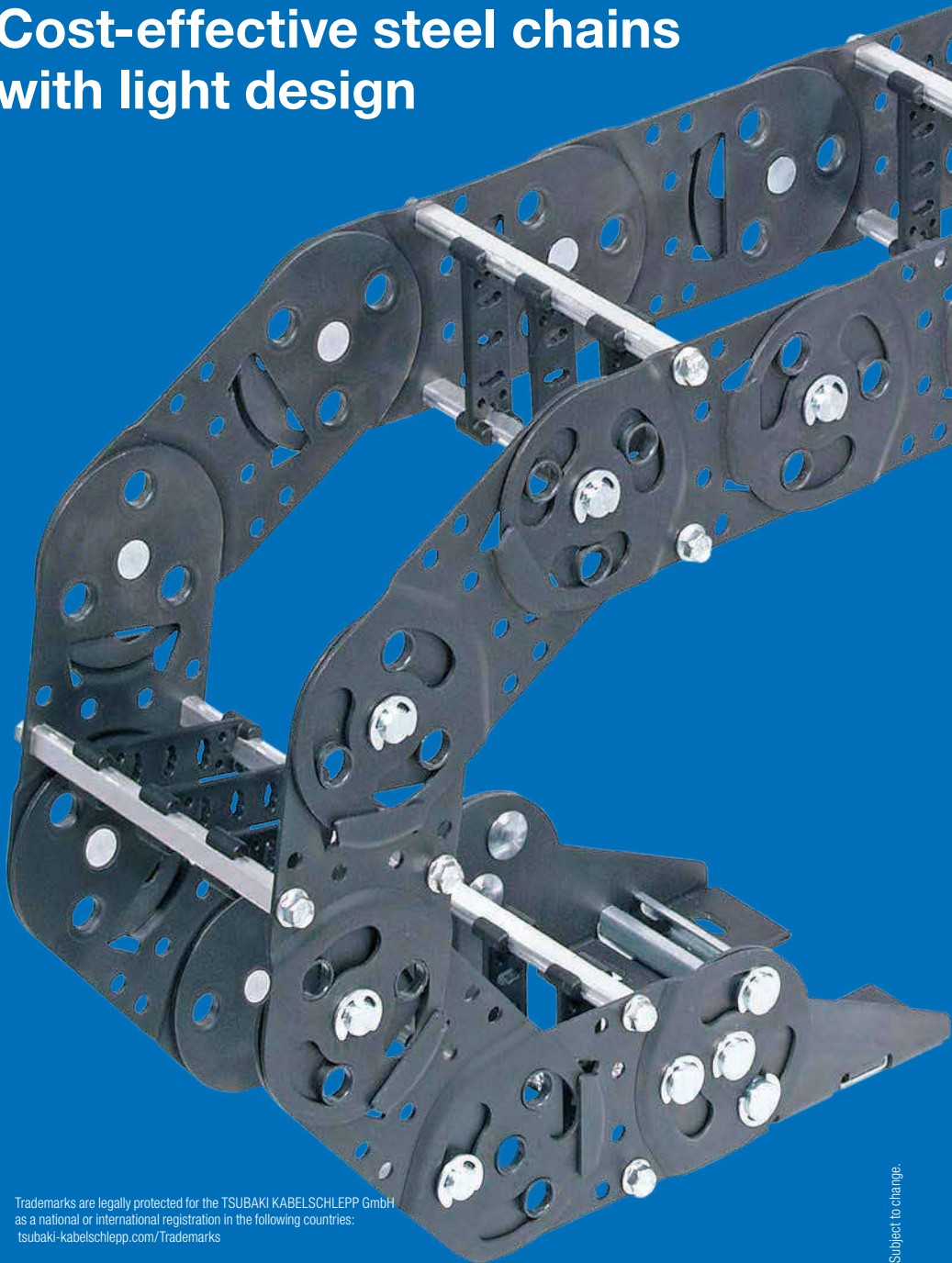

Trademarks are legally protected for the TSUBAKI KABELSCHLEPP GmbH
as a national or international registration in the following countries:
tsubaki-kabelschlepp.com/Trademarks

Subject to change.

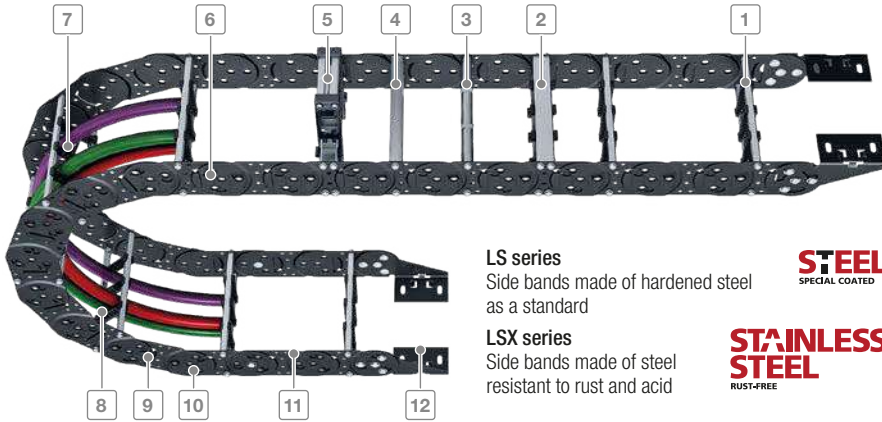

Inner heights



Chain widths



LS series

Side bands made of hardened steel as a standard

STEEL
SPECIAL COATED

LSX series

Side bands made of steel resistant to rust and acid

STAINLESS STEEL
RUST-FREE

- 1 All stays available in **1 mm width sections**
- 2 4-fold bolted aluminum stays for extreme loads
- 3 Rolling stays
- 4 Aluminum hole stays
- 5 Mounting frame stays
- 6 Stops integrated into link plate – no additional bolts required
- 7 Different separation options for the cables
- 8 Plastic or steel dividers
- 9 Weight-optimized side bands made of hardened steel or stainless steel
- 10 Optional center bolt for applications with high loads
- 11 Good ratio of inner to outer width – no end divider required
- 12 End connectors for different connection variants

tsubaki-kabelschlepp.com/
ls-lsx

Features

- Weight-optimized one-part link plate design
- Better value than comparable steel cable carriers
- Significantly higher unsupported lengths compared to plastic cable carriers of a similar size
- Integrated radius and pre-tension stops – in a good value design
- Bolted stay systems, solid end connectors
- Cover with steel band available on request
- Also possible as a double band solution
- Good corrosion resistance

The design

The weight-optimized link plate design makes the cable carriers very light yet highly sturdy. For the LS series, the unsupported length is significantly higher compared to plastic cable carriers of a similar size.



Weight-optimized link plates consist of only one plate – the stop system is integrated



Lightweight side bands without additional bolts – hardened steel or stainless steel



Optional: Center bolts and circlip for applications with high loads



Optional: C-rail for strain relief elements attached in the connection

Type	Opening variant	Stay variant	h _i [mm]	h _G [mm]	B _i [mm]	B _k [mm]	B _i -grid [mm]	t [mm]	KR [mm]	Additional load ≤ [kg/m]	Cable-d _{max} [mm]
LS/LSX1050											
		RS2	58	80	84 – 384	100 – 400	1	105	105 – 430	35	46
		RV	58	80	84 – 584	100 – 600	1	105	105 – 430	35	46
		RR	54	80	84 – 484	100 – 500	1	105	105 – 430	35	43
		LG	–	80	82 – 582	100 – 600	1	105	105 – 430	35	38
		RMA	58 (200)	80 (226)	184 – 384	200 – 400	1	105	105 – 430	35	–

* More information can be found in our technical manual.

Sturdy and durable, even under extreme conditions

Double-band steel cable carrier LS1050

- Up to 40% longer unsupported lengths compared to LS1050 with standard side band with the same additional load, as part of the load diagram
- Very high additional loads: up to 40 kg/m possible
- Long service life even with high dynamic loads
- High travel speeds



Longer service life through hardened side bands

The hardened surface significantly increases the service life of the LS1050. Tests were carried out on cable carriers with identical designs.

The LS1050 is therefore ideal for applications with many travel cycles, for example in 3-shift operation.

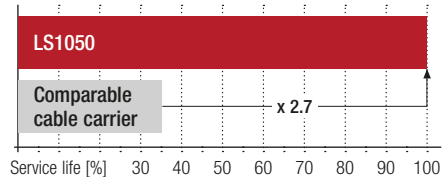

Technical manual

Do you need additional information on the LS/LSX series?
Our technical manual at tsubaki-kabelschlepp.com/download contains all information for selecting your cable carrier.

Unsupported arrangement			Gliding arrangement			Inner distribution				Installation variants			Page
Travel length \leq [m]	$v_{max} \leq$ [m/s]	$a_{max} \leq$ [m/s ²]	Travel length \leq [m]	$v_{max} \leq$ [m/s]	$a_{max} \leq$ [m/s ²]	TS0	TS1	TS2	TS3	vertical hanging or standing on the side	lying on the rotating arrangement		
9.5	5	10	-	-	-	●	●	●	●	●	-	-	594
9.5	5	10	-	-	-	●	●	●	●	●	-	-	598
9.5	5	10	-	-	-	●	●	-	-	●	-	-	602
9.5	5	10	-	-	-	-	-	-	-	●	-	-	604
9.5	5	10	-	-	-	●	-	-	-	●	-	-	*

Inner heights



Chain widths



tsubaki-kabelschlepp.com/
ls-lsx

Significantly higher unsupported lengths compared to plastic cable carriers of a similar size

Load diagram for unsupported length depending on the additional load

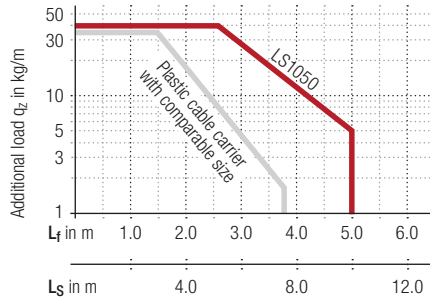
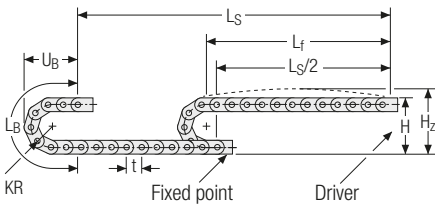

Weight-optimized through adapted link plate design

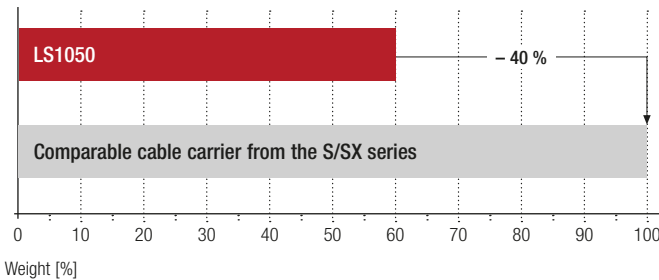

Subject to change.

LS/LSX1050

Key for abbreviations
on page 16

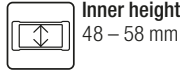

Stay variants

Design guidelines
from page 62



Aluminum stay RS 2 page 594

Frame stay narrow, bolted

- Quick to open and close.
- Aluminum profile bars for light to medium loads. Easy threaded connection.
- **Inside/outside:** Threaded joint easy to release.



Aluminum stay RV page 598

Frame stay, reinforced

- Aluminum profile bars for medium to heavy loads and large cable carrier widths. Double threaded joint on both sides.
- **Inside/outside:** Threaded joint easy to release.



Tube stay RR page 602

Frame stay, tube version

- Steel rolling stays with gentle cable support and steel dividers. Ideal for using media hoses with soft sheathing.
- **Inside/outside:** Screw connection detachable.



Aluminum stay LG page 604

Frame stay, split

- Optimum cable routing in the neutral bending line. Split version for easy cable routing. Stays also available unsplit.
- **Inside/outside:** Threaded joint easy to release.

Additional stay variants on request



Aluminum stay RMA
For guiding very large cable diameters.

Technical support:
technik@kabelschlepp.de

Unsupported arrangement

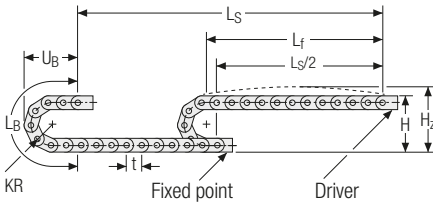

KR [mm]	H [mm]	L _B [mm]	U _B [mm]
105	330	540	250
125	370	603	270
155	430	697	300
195	510	823	340
260	640	1027	405
295	710	1137	440
325	770	1231	470
365	850	1357	510
430	980	1561	575

Inner heights



Chain widths



Installation height H_z

$H_z = H + 10 \text{ mm/m}$

Load diagram for unsupported length depending on the additional load.

Intrinsic cable carrier weight $q_k = 3.8 \text{ kg/m}$. For other inner widths, the maximum additional load changes.

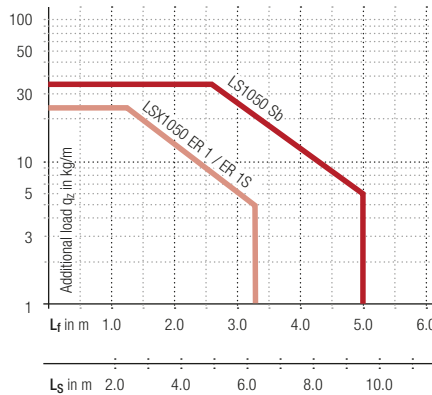

Speed
up to 5 m/s

Acceleration
up to 10 m/s²

Travel length
up to 9.5 m

Additional load
up to 35 kg/m

tsubaki-kabelschlepp.com/
ls-lsx



Information on selecting center bolts and stay arrangement

- Cable carrier length < 4 m: half-stayed arrangement as a standard
- Cable carrier length > 4 m: fully-stayed arrangement required
- Stay width B_{St} > 400 mm: fully-stayed arrangement required
- Travel speed > 2.5 m/s: fully-stayed arrangement required
- Use of support rollers: Center bolt **and** fully-stayed arrangement required

Aluminum stay RS 2 – frame stay narrow, threaded joint

- Quick to open and close
- Aluminum profile bars for light to medium loads. Simple threaded joint.
- Available customized in **1 mm grid**.
- **Inside/outside:** Threaded joint easy to release.



Key for abbreviations on page 16

Design guidelines from page 62

Technical support: technik@kabelschlepp.de



Stay arrangement on every 2nd chain link, standard (HS: half-stayed)



Stay arrangement on each chain link (VS: fully-stayed)



1 mm B_i 100 – 400 mm in 1 mm width sections

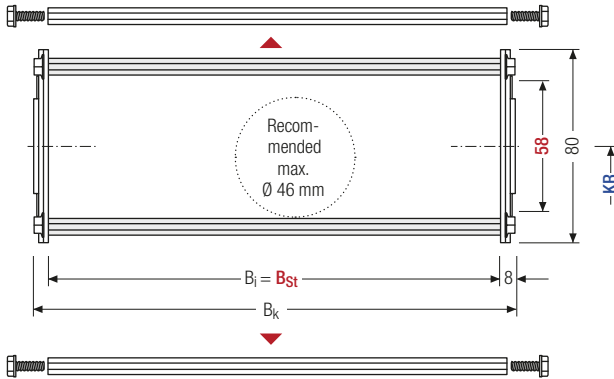

The maximum cable diameter strongly depends on the bending radius and the desired cable type. Please contact us.

Calculating the cable carrier length

Cable carrier length L_k

$$L_k \approx \frac{L_S}{2} + L_B$$

Cable carrier length L_k rounded to pitch t

h_i [mm]	h_G [mm]	B_i [mm]	B_{St} [mm]*	B_k [mm]	KR [mm]					q_k [kg/m]
58	80	84 384	84 384	$B_{St} + 16$	105 295	125 325	155 365	195 430	260	3.63 4.11

* in 1 mm width sections

Order example

LS1050 · 180 · RS 2 · 125 · Sb · 2415 · HS
 Type B_{St} [mm] Stay variant KR [mm] Material L_k [mm] Stay arrangement

Divider systems

As a standard, the divider system is mounted on each crossbar – for stay mounting on every 2nd chain link (HS).

For applications with lateral acceleration and rotated by 90°, the dividers can be attached by simply clipping on a socket (available as an accessory).

As a standard, dividers and the complete divider system (dividers with height separations) can be moved in the cross section (**version A**).

The socket additionally serves as a spacer between the dividers and is available in 1 mm sections between 3 – 50 mm as well as 16.5 and 21.5 mm (**version B**).

Inner heights



Chain widths



Increments



Divider system TS0 without height separation

Vers.	a _T min [mm]	a _x min [mm]	a _c min [mm]	n _T min
A	7	14	10	–

The dividers can be moved in the cross section.

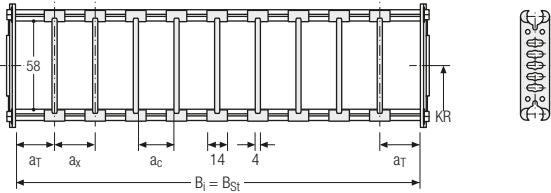

Divider system TS1 with continuous height separation

Vers.	a _T min [mm]	a _T max [mm]	a _x min [mm]	a _c min [mm]	n _T min
A	7	25	14	10	2

The dividers can be moved in the cross section.

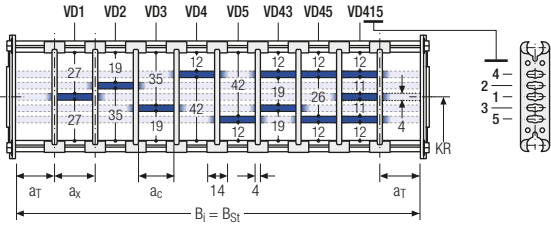

Divider system TS2 with partial height separation

Vers.	a _T min [mm]	a _x min [mm]	a _c min [mm]	n _T min
A	7	23	19	2

With grid distribution (1 mm grid). The dividers are attached by the height separation, the grid can be moved in the cross section.

Sliding dividers are optionally available (thickness of divider = 4 mm).

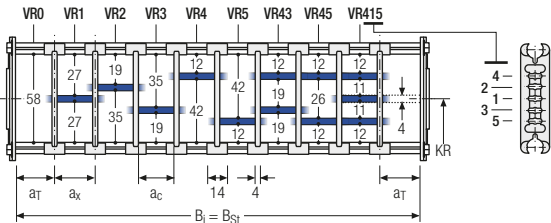

Please note that the real dimensions may deviate slightly from the values indicated here.

Order example

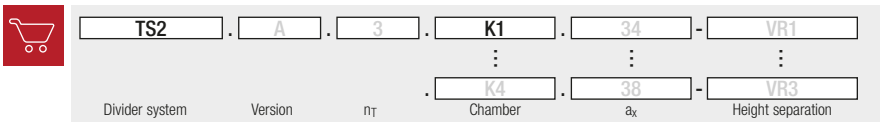

Divider system TS3 with height separation consisting of plastic partitions

As a standard, the divider **version A** is used for vertical partitioning within the cable carrier. The complete divider system can be moved within the cross section.

Key for abbreviations on page 16

Design guidelines from page 62

Technical support: technik@kabelschlepp.de

Divider version A

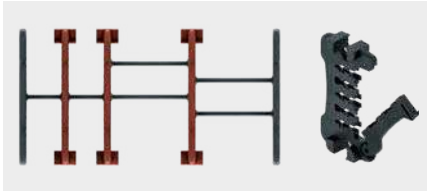

End divider

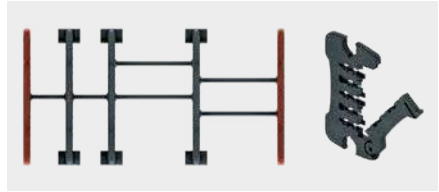

Vers.	a_T min [mm]	a_x min [mm]	a_c min [mm]	n_T min
A	6/2*	14	10	2

* For End divider

The dividers are fixed by the partitions, the complete divider system is movable in the cross section.

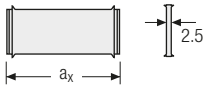
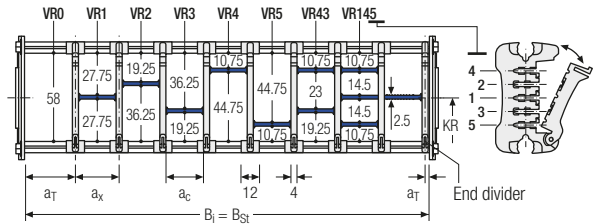

a_x (center distance of dividers) [mm]																
a_c (nominal width of inner chamber) [mm]																
14	16	19	23	24	28	29	32	33	34	38	39	43	44	48	49	54
10	12	15	19	20	24	25	28	29	30	34	35	39	40	44	45	50
58	59	64	68	69	74	78	79	80	84	88	89	94	96	99	112	
54	55	60	64	65	70	74	75	76	80	84	85	90	92	95	108	

When using partitions with $a_x > 49$ mm we recommended an additional preferential central support.

Order example

	TS3	.	A	.	3	.	K1	.	34	-	VR1
							⋮		⋮		⋮
							K4	.	38	-	VR3
	Divider system		Version		n_T		Chamber		a_x		Height separation

Please state the designation of the divider system (TS0, TS1,...), version and number of dividers per cross section n_T . In addition, please also enter the chambers [K] from left to right, as well as the assembly distances $[a_T/a_x]$ (as seen from the driver).

If using divider systems with height separation (TS1, TS3) please also state the positions [e.g. VD23] viewed from the left driver belt. You are welcome to add a sketch to your order.



Subject to change.

LS/LSX
series

Inner
heights



Chain
widths



Incre-
ments



tsubaki-kabelschlepp.com/
ls-lsx

Aluminum stay RV – frame stay reinforced

- Aluminum profile bars for medium to heavy loads and large cable carrier widths. Double threaded joint on both sides.
- Available customized in **1 mm grid**.
- **Inside/outside:** Threaded joint easy to release.

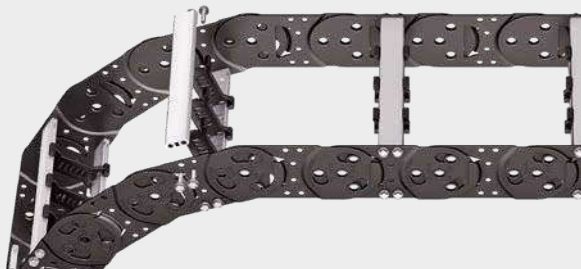

Key for abbreviations on page 16

Design guidelines from page 62

Technical support: technik@kabelschlepp.de

Stay arrangement on every 2nd chain link, standard (HS: half-stayed)

Stay arrangement on each chain link (VS: fully-stayed)

1 mm B_i 100 – 600 mm in **1 mm** width sections

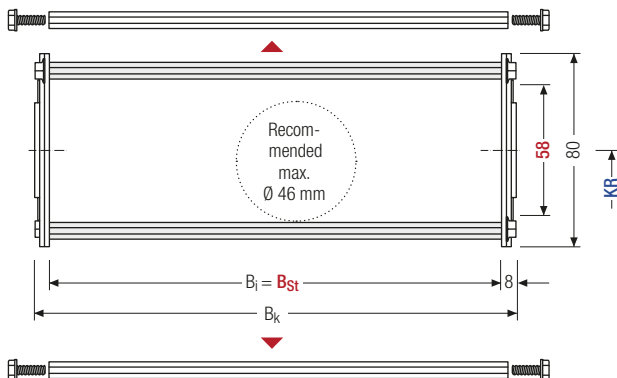

The maximum cable diameter strongly depends on the bending radius and the desired cable type. Please contact us.

Calculating the cable carrier length

Cable carrier length L_k

$$L_k \approx \frac{L_S}{2} + L_B$$

Cable carrier length L_k rounded to pitch t

h _i [mm]	h _G [mm]	B _i [mm]	B _{St} [mm]*	B _k [mm]	KR [mm]					q _k [kg/m]
58	80	84	84	B _{St} + 16	105	125	155	195	260	4.00
		584	584		295	325	365	430	5.95	

* in 1 mm width sections

Order example

LS1050 · 180 · RV · 125 · Sb · 2415 · HS
Type · B_{St} [mm] · Stay variant · KR [mm] · Material · L_k [mm] · Stay arrangement

Divider systems

As a standard, the divider system is mounted on each crossbar – for stay mounting on every 2nd chain link (HS).

As a standard, dividers and the complete divider system (dividers with height separations) can be moved in the cross section (**version A**).

Inner heights



Divider system TS0 without height separation

Vers.	a _T min [mm]	a _x min [mm]	a _c min [mm]	π _T min
A	7	14	10	–

The dividers can be moved in the cross section.

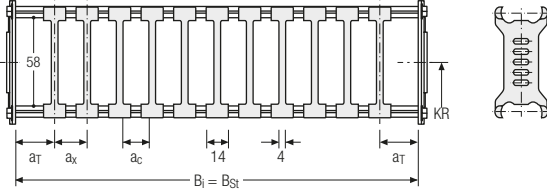

Chain widths



Divider system TS1 with continuous height separation

Vers.	a _T min [mm]	a _T max [mm]	a _x min [mm]	a _c min [mm]	π _T min
A	7	25	14	10	2

The dividers can be moved in the cross section.

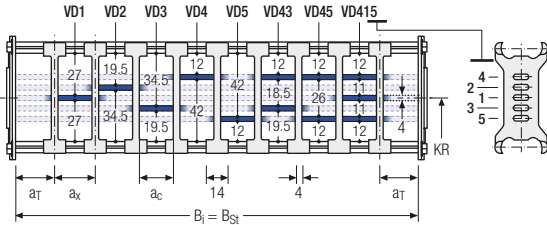

Increments



Divider system TS2 with partial height separation

Vers.	a _T min [mm]	a _x min [mm]	a _c min [mm]	π _T min
A	8	21	15	2

With grid distribution (1 mm grid). The dividers are attached by the height separation, the grid can be moved in the cross section.

Sliding dividers are optionally available (thickness of divider = 4 mm).

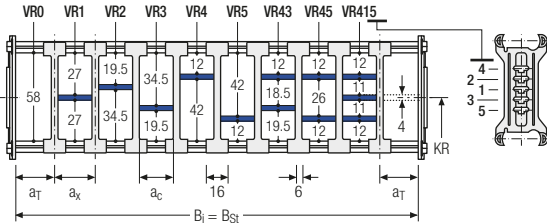

tsubaki-kabelschlepp.com/
ls-lsx

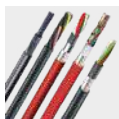

TRAXLINE® cables for cable carriers

Hi-flex electric cables which were especially developed, optimized and tested for use in cable carriers can be found at traxline.de

LS/LSX1050 RV | Inner Distribution | TS3

Divider system TS3 with height separation made of plastic partitions

Vers.	a_T min [mm]	a_x min [mm]	a_c min [mm]	n_T min
A	4	16 / 42*	8	2

* For aluminum partitions

The dividers are fixed by the partitions, the complete divider system is movable in the cross section.

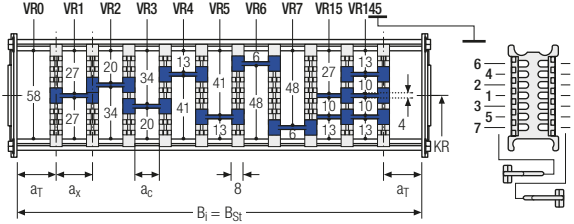

Key for abbreviations on page 16

Design guidelines from page 62

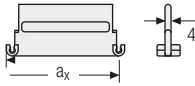

Aluminum partitions in 1 mm increments with $a_x > 42$ mm are also available.

a_x (center distance of dividers) [mm]											
a_c (nominal width of inner chamber) [mm]											
16	18	23	28	32	33	38	43	48	58	64	68
8	10	15	20	24	25	30	35	40	50	56	60
78	80	88	96	112	128	144	160	176	192	208	
70	72	80	88	104	120	136	152	168	184	200	

When using plastic partitions with $a_x > 112$ mm, we recommend an additional center support with a twin divider ($S_T = 4$ mm). Twin dividers are also suitable for retrofitting in the partition system.

Order example

TS3

A

3

K1

34

VR1

K4

38

VR3

Divider system
Version
 n_T
Chamber
 a_x
Height separation

Please state the designation of the divider system (TS0, TS1 ...), version and number of dividers per cross section n_T . In addition, please also enter the chambers [K] from left to right, as well as the assembly distances $[a_T/a_x]$ (as seen from the driver).

If using divider systems with height separation (TS1, TS3) please also state the positions [e.g. VD23] viewed from the left carrier belt. You are welcome to add a sketch to your order.

Technical support: technik@kabelschlepp.de

online-engineer.de
Cable Carrier Configurator

More product information online



Assembly instructions etc.: Additional info via your smartphone or check online at tsubaki-kabelschlepp.com/support



Configure your custom cable carrier here: onlineengineer.de

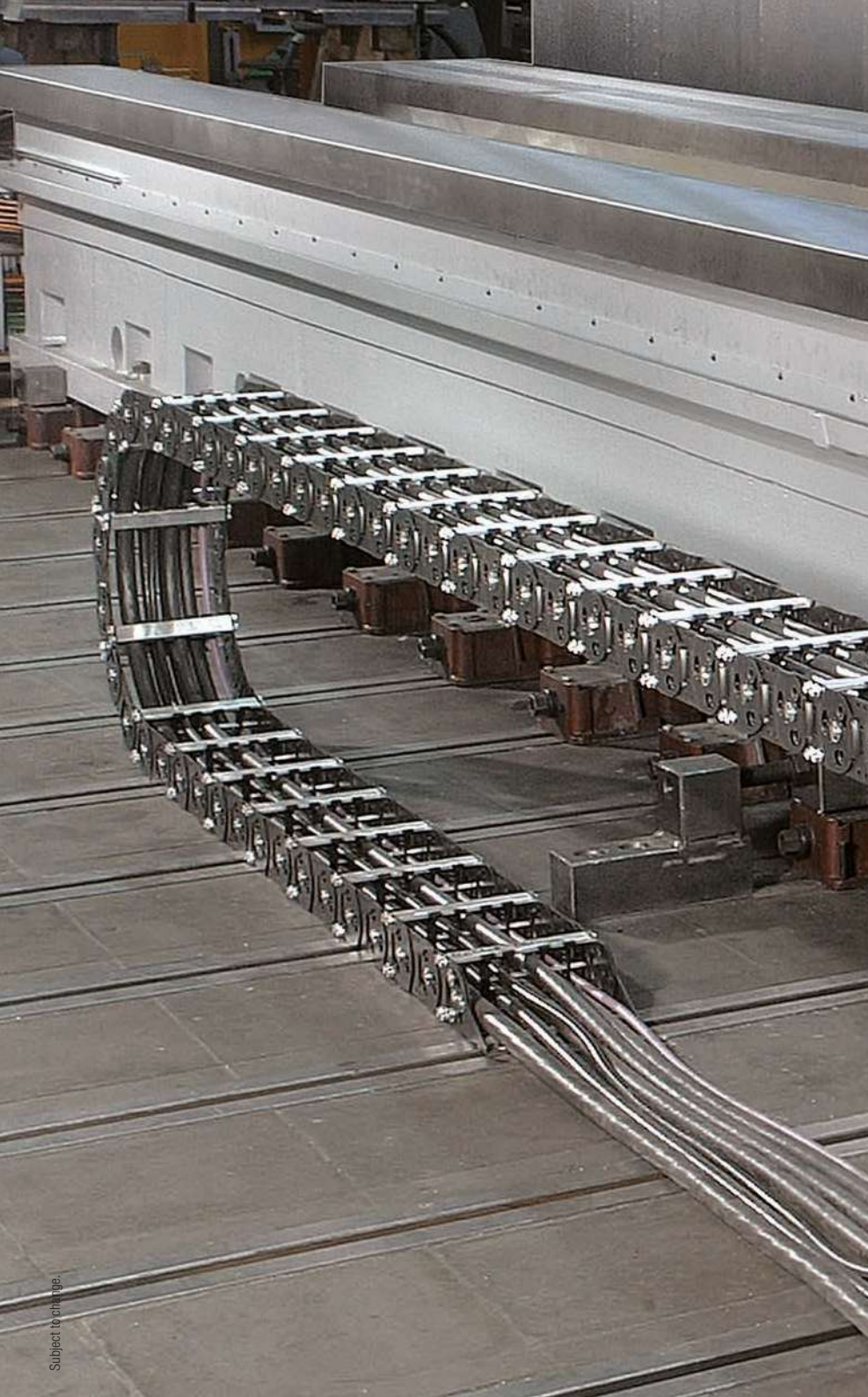

LS/LSX
series

Inner
heights



Chain
widths



Incre-
ments



tsubaki-kabelschlepp.com/
ls-lsx

Subject to change.

Tube stay RR – frame stay, tube version

- Steel rolling stays with gentle cable support and steel dividers. Ideal for using media hoses with soft sheathing. Easy screw connection.
- Available customized in **1 mm width sections**.
- **Inside/outside: Screw connection detachable**
- **Option:** Divider systems made from steel and stainless steel ER 1, ER 1S.



Key for abbreviations on page 16

Design guidelines from page 62

Technical support: technik@kabelschlepp.de

Stay arrangement on every 2nd chain link standard (HS: half-stayed)

Stay arrangement on each chain link (VS: fully-stayed)

1 mm B_i 100 – 500 mm in 1 mm width sections

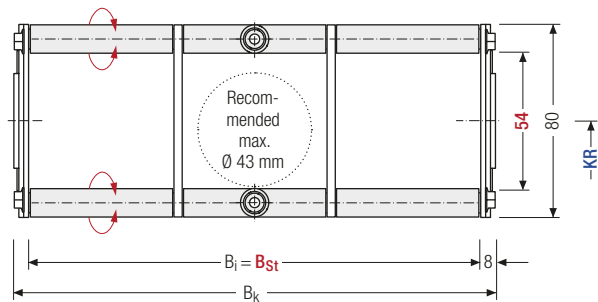

The maximum cable diameter strongly depends on the bending radius and the desired cable type. Please contact us.

Calculating the cable carrier length

Cable carrier length L_k

$$L_k \approx \frac{L_s}{2} + L_B$$

Cable carrier length L_k rounded to pitch t for odd number of chain links

h _i [mm]	h _G [mm]	B _i [mm]	B _{St} [mm]*	B _k [mm]	KR [mm]					q _k [kg/m]
54	80	84	84	B _{St} + 16	105	125	155	195	260	4,25
		484	484		295	325	365	430	7,80	

* in 1 mm width sections

LS1050 · 180 B_{St} [mm] · RR Stay variant · 125 KR [mm] · Sb Material · 2415 L_k [mm] · HS Stay arrangement

Divider systems

As a standard, the divider system is mounted on each crossbar – for stay mounting on every 2nd chain link (HS).

The dividers are fixed through the tubes. The tube additionally serves as a spacer between the dividers (**version B**).

Divider system TS0 without height separation

Vers.	a _T min [mm]	a _X min [mm]	a _C min [mm]	n _T min
B	20	20	16	–

The dividers can be moved in the cross section.

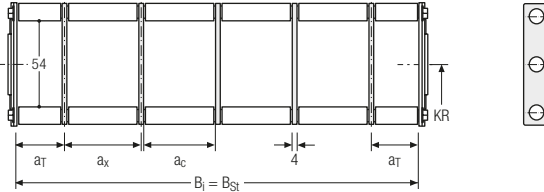

Inner heights



Chain widths



Increments



Divider system TS1 with continuous height separation

Vers.	a _T min [mm]	a _T max [mm]	a _X min [mm]	a _C min [mm]	n _T min
B	20	25	20	16	2

The dividers can be moved in the cross section.

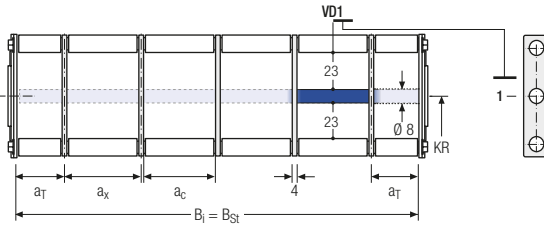

tsubaki-kabelschlepp.com/
ls-lsx

Order example

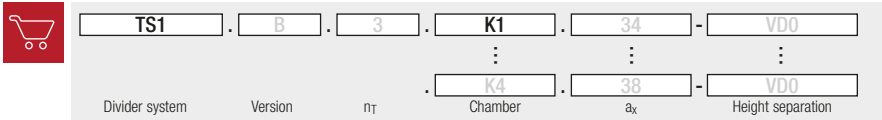

Please state the designation of the divider system (**TS0, TS1 ...**), version and number of dividers per cross section [n_T]. In addition, please also enter the chambers [K] from left to right, as well as the assembly distances [a_T/a_X] (as seen from the driver).



TRAXLINE® cables for cable carriers

Hi-flex electric cables which were especially developed, optimized and tested for use in cable carriers can be found at traxline.de

Aluminum stay LG – hole stay, split version

- Optimum cable routing in the neutral bending line. Split version for easy cable routing. Stays also available unsplit.
- Available customized in **1 mm grid**.
- **Inside/outside:** Threaded joint easy to release.



Key for abbreviations on page 16

Design guidelines from page 62

Technical support: technik@kabelschlepp.de



Stay arrangement on every 2nd chain link standard (HS: half-stayed)



Stay arrangement on each chain link (VS: fully-stayed)



1 mm B_i 100 – 600 mm in 1 mm width sections

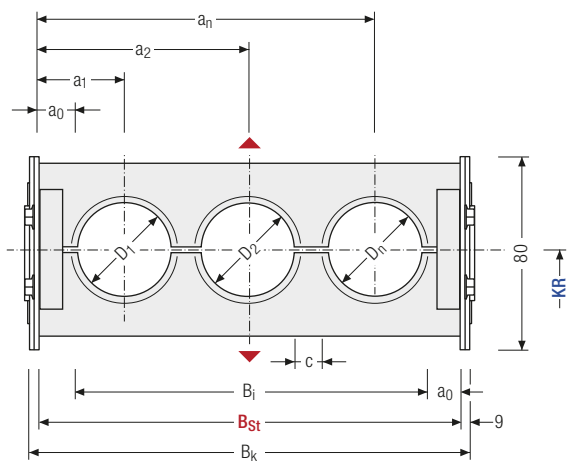

i The maximum cable diameter strongly depends on the bending radius and the desired cable type. Please contact us.

Calculating the cable carrier length

Cable carrier length L_k

$$L_k \approx \frac{L_s}{2} + L_B$$

Cable carrier length L_k rounded to pitch t

Calculating the stay width

Stay width B_{St}

$$B_{St} = \sum D + \sum c + 2 a_0$$

D _{max} [mm]	h _G [mm]	B _i [mm]	B _{St} [mm]*	B _k [mm]	c _{min} [mm]	a _{0 min} [mm]	KR [mm]				q _{k 50 %} ** [kg/m]	
48	80	54	82	B _{St} + 18	4	14	105	125	155	195	260	4,00
		554	582				295	325	365	430	7,99	

* in 1 mm width sections ** Hole ratio of the hole stay approx. 50 %

LS1050 · 180 B_i [mm] · LG Stay variant · 125 KR [mm] · Sb Material · 2415 L_k [mm] · HS Stay arrangement

End connectors – steel

End connectors made of steel. The connection variants on the fixed point and on the driver can be combined and, if required, changed afterwards.

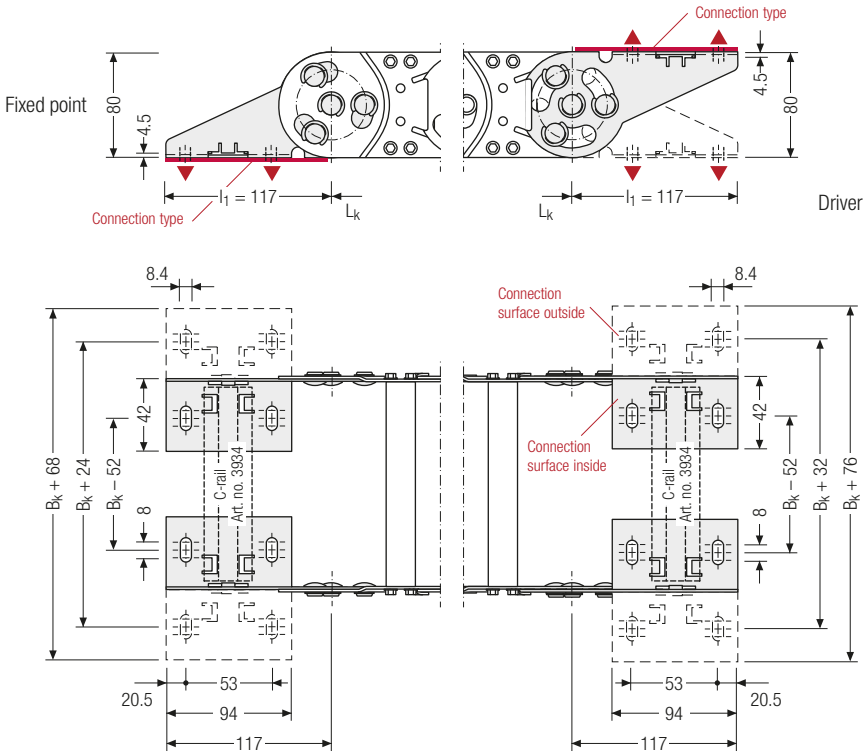

▲ Assembly options

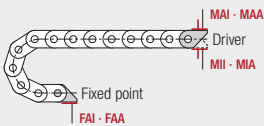

Connection point

- F** – fixed point
- M** – driver

Connection type

- A** – threaded joint outside (standard)
- I** – threaded joint inside

Connection surface

- I** – connection surface inside
- A** – connection surface outside

Inner heights



Chain widths



tsubaki-kabelschlepp.com/
ls-lsx

Order example

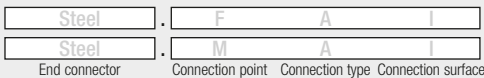

We recommend the use of strain reliefs before driver and fixed point. See from p. 794.